

# TUPAI<sup>®</sup>

---







TABELA DE PREÇOS '15  
PRICE TABLE

A modern bathroom featuring a glass shower enclosure, a dark wood vanity with a white countertop, and a large mirror. The floor is made of large, dark tiles. The image is overlaid with a semi-transparent grid pattern.

**ACESSÓRIOS DE BANHO**  
**BATHROOM ACCESSORIES**

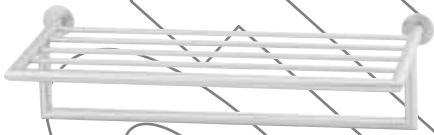

## ACESSÓRIOSBANHO • BATHACCESSORIES

REF.	DESCRIPTION	FINISHING	SIZE	PRICE	QUANT.	KG.
REF. 5020		16	400	31,20	1	0,77
		58	500	34,80	1	0,86
REF. 5021		16	400	33,15	1	0,77
		58	500	37,10	1	0,86
REF. 5024		16		84,45	1	1,80
		58		88,44	1	1,80
REF. 5026		16		55,60	1	2,00
		58		58,50	1	2,00
REF. 5023		16		25,75	1	0,53
		58		27,42	1	0,53
REF. 5022		16		17,00	1	0,35
		58		18,05	1	0,35
REF. 5025		16		11,10	1	0,17
		58		11,80	1	0,17











## ACESSÓRIOSBANHO • BATHACCESSORIES

REF.	DESCRIPTION	FINISHING	PRICE	QUANT.	KG.
REF. 5030		16 aço inox satinado satin stainless steel	47,90	1	0,87
		58 aço inox polido polished stainless steel	48,25	1	0,92
REF. 5032		16 aço inox satinado satin stainless steel	61,45	1	0,87
		58 aço inox polido polished stainless steel	64,20	1	0,92
REF. 5031		16 aço inox satinado satin stainless steel	42,00	1	0,74
		58 aço inox polido polished stainless steel	52,65	1	0,74
REF. 5036		16 aço inox satinado satin stainless steel	45,40	1	0,74
		58 aço inox polido polished stainless steel	58,15	1	0,74
REF. 5033		16 aço inox satinado satin stainless steel	79,35	1	1,80
		58 aço inox polido polished stainless steel	90,45	1	1,80
REF. 5033		16 aço inox satinado satin stainless steel	69,60	1	1,04
		58 aço inox polido polished stainless steel	82,05	1	1,04

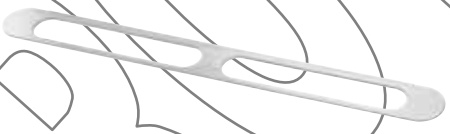











## ACESSÓRIOSBANHO • BATHACCESSORIES

REF. 5034		16	aço inox satinado satin stainless steel	32,85	1	0,46
Porta rolos.   Toilet paper rack.		58	aço inox polido polished stainless steel	41,95	1	0,46
REF. 5037		16	aço inox satinado satin stainless steel	38,00	1	0,56
Toalheiro duplo.   Double towel rack.		58	aço inox polido polished stainless steel	46,95	1	0,56
REF. 5035		16	aço inox satinado satin stainless steel	26,65	1	0,22
Cabide simples.   simple hook.		58	aço inox polido polished stainless steel	33,75	1	0,22
REF. 5040		16	aço inox satinado satin stainless steel	43,35	1	0,74
Toalheiro simples.   Simple towel rack.		58	aço inox polido polished stainless steel	65,00	1	0,74
REF. 5041		16	aço inox satinado satin stainless steel	62,50	1	0,14
Toalheiro duplo.   Double towel rack.		58	aço inox polido polished stainless steel	93,75	1	0,14
REF. 5042		16	aço inox satinado satin stainless steel	61,05	1	1,60
Toalheiro simples.   Simple towel rack.		58	aço inox polido polished stainless steel	91,60	1	1,60
REF. 5044		16	aço inox satinado satin stainless steel	40,80	1	0,72
Toalheiro de argola.   Ring towel rack.		58	aço inox polido polished stainless steel	61,25	1	0,72
REF. 5043		16	aço inox satinado satin stainless steel	38,75	1	0,80
Toalheiro de argola.   Ring towel rack.		58	aço inox polido polished stainless steel	58,10	1	0,80
REF. 5049		16	aço inox satinado satin stainless steel	75,55	1	1,80
Prateleira de vidro.   Glass shelf.		58	aço inox polido polished stainless steel	113,35	1	1,80









ACESSÓRIOSBANHO • BATHACCESSORIES

<p>REF. 5047</p>		<p><b>16</b> aço inox satinado satin stainless steel <b>19,90</b> 1 0,44</p>
<p>Saboneteira.   Soap rack.</p>		<p><b>58</b> aço inox polido polished stainless steel <b>28,35</b> 1 0,44</p>
<p>REF. 5045</p>		<p><b>16</b> aço inox satinado satin stainless steel <b>26,45</b> 1 0,58</p>
<p>Porta rolos.   Toilet paper rack.</p>		<p><b>58</b> aço inox polido polished stainless steel <b>39,70</b> 1 0,58</p>
<p>REF. 5050</p>		<p><b>16</b> aço inox satinado satin stainless steel <b>45,95</b> 1 0,54</p>
<p>Porta rolos com tampa.   Toilet paper rack with cover.</p>		<p><b>58</b> aço inox polido polished stainless steel <b>68,95</b> 1 0,54</p>
<p>REF. 5048</p>		<p><b>16</b> aço inox satinado satin stainless steel <b>23,70</b> 1 0,52</p>
<p>Porta copos.   Cup rack.</p>		<p><b>58</b> aço inox polido polished stainless steel <b>39,70</b> 1 0,52</p>
<p>REF. 5046</p>		<p><b>16</b> aço inox satinado satin stainless steel <b>10,95</b> 1 0,11</p>
<p>Cabide simples.   simple hook.</p>		<p><b>58</b> aço inox polido polished stainless steel <b>16,40</b> 1 0,11</p>



## ACESSÓRIOSBANHO • BATHACCESSORIES

REF. 5060		16	aço inox satinado satin stainless steel	300	<b>25,30</b>	1	0,49
Toalheiro simples.   Simple towel rack.				450	<b>29,25</b>	1	0,61
				600	<b>33,20</b>	1	0,76
REF. 5062		16	aço inox satinado satin stainless steel		<b>25,75</b>	1	0,37
Porta rolos.   Toilet paper rack.							
REF. 5064		16	aço inox satinado satin stainless steel		<b>11,10</b>	1	0,15
Cabide simples.   simple hook.							
REF. 5065		16	aço inox satinado satin stainless steel		<b>10,00</b>	1	0,11
Cabide simples.   simple hook.							
REF. 5067		16	aço inox satinado satin stainless steel		<b>29,40</b>	1	0,49
Saboneteira.   Soap rack.							
REF. 5068		16	aço inox satinado satin stainless steel		<b>37,25</b>	1	0,74
Saboneteira XL.   XL Soap rack.							







## ACESSÓRIOSBANHO • BATHACCESSORIES

REF. 5070		16	450 aço inox satinado satin stainless steel	16,40	1	0,45
Toalheiro simples.   Simple towel rack.			600 aço inox satinado satin stainless steel	18,55	1	0,62
REF. 5074		16	aço inox satinado satin stainless steel	80,95	1	0,34
Toalheiro com prateleira.   Towel bar rack with shelf.						
REF. 5076		16	aço inox satinado satin stainless steel	22,91	1	0,55
Toalheiro de argola.   Ring towel rack.						
REF. 5072		16	aço inox satinado satin stainless steel	16,40	1	0,41
Porta rolos.   Toilet paper rack.						
REF. 5075		16	aço inox satinado satin stainless steel	8,30	1	0,14
Cabide simples.   simple hook.						
REF. 5073		16	aço inox satinado satin stainless steel	23,50	1	0,50
Saboneteira.   Soap rack.						



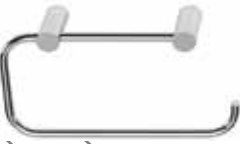

## ACESSÓRIOSBANHO • BATHACCESSORIES

REF.	DESCRIPTION	FINISHING	PRICE	QUANT.	KG.
REF. 6000		3 cromado brilhante bright chrome	300	30,80	1 0,44
		3 cromado brilhante bright chrome	450	33,60	1 0,50
		3 cromado brilhante bright chrome	600	36,95	1 0,58
Toalheiro simples.   Simple towel rack.					
REF. 6001		3 cromado brilhante bright chrome	300	42,95	1 0,78
		3 cromado brilhante bright chrome	450	46,30	1 0,72
		3 cromado brilhante bright chrome	600	50,95	1 0,92
Toalheiro duplo.   Double towel rack.					
REF. 6008		3 cromado brilhante bright chrome		114,35	1 3,00
Toalheiro com prateleira.   Towel bar rack with shelf.					
REF. 6007		3 cromado brilhante bright chrome		30,80	1 0,38
Porta rolos.   Toilet paper rack.					
REF. 6003		3 cromado brilhante bright chrome		50,55	1 0,58
Saboneteira.   Soap rack.					
REF. 6004		3 cromado brilhante bright chrome		52,40	1 0,88
Prateleira de banho.   Bath shelf.					



## ACESSÓRIOSBANHO • BATHACCESSORIES

REF. 6011



Asa simples de apoio. | Simple hand holder.

3

cromado brilhante  
bright chrome

33,10

1

1,09

REF. 6002



Porta rolos. | Toilet paper rack.

3

cromado brilhante  
bright chrome

32,75

1

0,33

REF. 6010



Cabide simples. | simple hook.

3

cromado brilhante  
bright chrome

28,00

1

0,28

REF. 6005



Cabide simples. | simple hook.

3

cromado brilhante  
bright chrome

14,60

1

0,10

REF. 5096



Toalheiro de pé. | Stand-up towel rack.

16

aço inox satinado  
satin stainless steel

64,37

1

4,00

58

aço inox polido  
polished stainless steel

64,37

1

4,00

REF. 5097



Toalheiro de pé. | Stand-up towel rack.

16

aço inox satinado  
satin stainless steel

78,40

1

4,20

58

aço inox polido  
polished stainless steel







78,40

1

4,20



## ACESSÓRIOSBANHO • BATHACCESSORIES

REF. 5118		16	aço inox satinado satin stainless steel	46,65	1	1,02
Porta piaçaba de chão redondo.   Round floor brush rack.		58	aço inox polido polished stainless steel	50,25	1	1,02
REF. 5078		16	aço inox satinado satin stainless steel	46,65	1	1,20
Porta piaçaba de chão quadrado.   Square floor brush rack.		58	aço inox polido polished stainless steel	50,30	1	1,20
REF. 5079		16	aço inox satinado satin stainless steel	32,70	1	1,35
Porta piaçaba de chão quadrado.   Square floor brush rack.		58	aço inox polido polished stainless steel	34,90	1	1,35
REF. 5008		16	aço inox satinado satin stainless steel	43,25	1	1,22
Porta piaçaba de chão redondo.   Round floor brush rack.		58	aço inox polido polished stainless steel	45,45	1	1,22
REF. 5009		16	aço inox satinado satin stainless steel	33,10	1	1,20
Porta piaçaba de chão redondo.   Round floor brush rack.		58	aço inox polido polished stainless steel	35,85	1	1,20
REF. 6009		3	cromado brilhante bright chrome	64,90	1	1,20
Porta piaçaba de chão redondo.   Round floor brush rack.						



ACESSÓRIOS BANHO • BATH ACCESSORIES

REF. 5120



16 aço inox satinado  
satin stainless steel

51,12 1 2,00

Dispensador de papel para mãos.  
Paper towel dispenser.

REF. 5122



16 aço inox satinado  
satin stainless steel

42,50 1 1,60

Porta rolos.  
Roll tissue dispenser.

REF. 5125



16 aço inox satinado  
satin stainless steel

178,60 1 4,40

Secador de mãos automático.  
Automatic hands drier.

REF. 5133



16 aço inox satinado  
satin stainless steel

71,70 1 3,20

Papeleira.  
wall waste receptacle.



## ACESSÓRIOSBANHO • BATHACCESSORIES

REF. 5128

**16** aço inox satinado  
satin stainless steel**10,90**

1

0,24

Doseador de sabonete.  
Soap dispenser.**58** aço inox polido  
polished stainless steel**10,90**

1

0,24

REF. 5091

**16** aço inox satinado  
satin stainless steel**31,15**

1

0,44

Doseador de sabonete de parede.  
Wall soap dispenser.

REF. 5129

**16** aço inox satinado  
satin stainless steel**5,70**

1

0,13

Saboneteira.  
Soap rack.**58** aço inox polido  
polished stainless steel**5,70**

1

0,13



## ACESSÓRIOSBANHO • BATHACCESSORIES

REF. 8



<b>16</b>	aço inox satinado satin stainless steel	<b>21,43</b>	1	0,65
-----------	--	--------------	---	------

Balde.  
Bucket.

<b>58</b>	aço inox polido polished stainless steel	<b>21,43</b>	1	0,65
-----------	---	--------------	---	------

REF. 7



<b>16</b>	aço inox satinado satin stainless steel	<b>28,39</b>	1	0,82
-----------	--	--------------	---	------

Balde.  
Bucket.

<b>58</b>	aço inox polido polished stainless steel	<b>28,39</b>	1	0,82
-----------	---	--------------	---	------

REF. 5

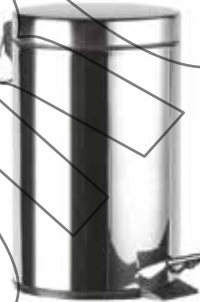

<b>16</b>	aço inox satinado satin stainless steel	<b>31,85</b>	1	1,60
-----------	--	--------------	---	------

Balde.  
Bucket.

<b>58</b>	aço inox polido polished stainless steel	<b>31,85</b>	1	1,60
-----------	---	--------------	---	------

REF. 4



<b>58</b>	aço inox polido polished stainless steel	<b>24,10</b>	1	1,23
-----------	---	--------------	---	------

Balde.  
Bucket.