



SILERE[®]: a excelência em sistemas de drenagem silenciosos

SILERE[®], O SISTEMA DE DRENAGEM INSONORIDADO DE ENCAIXE DE EXCELÊNCIA



Nos últimos anos assistiu-se a um aumento da atenção dada ao ruído gerado nos sistemas de drenagem no interior dos edifícios, envolvendo vários aspetos, tais como planeamento urbano, técnicas construtivas, distribuição de compartimentos e o isolamento acústicos dos sistemas.

Silere[®] é o sistema de encaixe composto por tubos e acessórios industrializado, produzido e patenteado pela Valsir que responde a estas exigências garantindo os níveis de silêncio nos sistemas de drenagem como requerido pelos regulamentos legislativos e normativos em vigor.





Excelentes performance fono-isolantes do sistema:, 6 dB(A) com um caudal de 2 l/s.



Ampla gama de acessórios de interligação com outros sistemas de drenagem como o ferro, PE, PP, PVC.



Elevada resistência ao impacto a temperatura baixas (até -20°C).



Baixo coeficiente de dilatação térmica.



Elevada velocidade e facilidade de instalação sem a utilização de qualquer ferramenta particular, graças ao sistema de união por encaixe.



O encaixe por abocardamento não necessita da utilização suplementar de colas ou solventes nocivos.



Resistência a descargas descontinuas com temperaturas até 95°C.



O produto, a sua reciclabilidade e os processos produtivos são baseados nos princípios do Green Building.



Elevada resistência química às substâncias dissolvidas e presentes nas descargas civis e industriais.

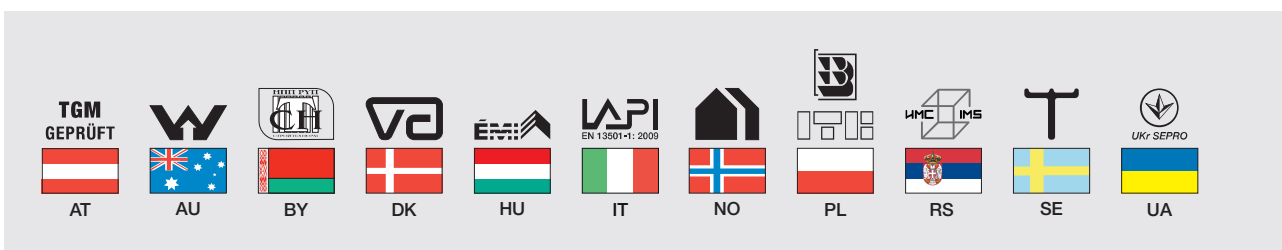

GAMA SILERE

HTEM tubo 1 boca

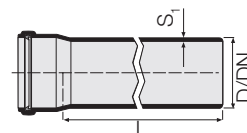

COD.	D	DN	s ₁	L	kg		QMM	€/un
PB40000220005	58	50	4,0	500	0,697	4	4	9.42 €
PB40000220007	58	50	4,0	1000	1,274	16	16	15.46 €
PB40000220009	58	50	4,0	2000	2,500	16	16	27.49 €
PB40000220011	58	50	4,0	3000	3,750	16	1	39.50 €
PB40000220025	78	70	4,5	500	1,059	4	4	9.99 €
PB40000220027	78	70	4,5	1000	1,967	16	16	16.28 €
PB40000220029	78	70	4,5	2000	3,750	16	16	28.86 €
PB40000220031	78	70	4,5	3000	5,500	16	1	41.40 €
PB40000220045	90	90	4,5	500	0,013	4	4	11.45 €
PB40000220047	90	90	4,5	1000	2,282	12	12	18.71 €
PB40000220049	90	90	4,5	2000	4,250	12	12	33.33 €
PB40000220050	90	90	4,5	3000	6,500	12	1	49.03 €
PB40000220055	110	100	5,4	500	1,753	4	4	12.95 €
PB40000220057	110	100	5,4	1000	3,500	15	15	21.28 €
PB40000220059	110	100	5,4	2000	6,250	15	15	38.12 €
PB40000220061	110	100	5,4	3000	9,500	15	1	55.66 €
PB40000220075	135	125	5,6	500	2,405	4	4	18.28 €
PB40000220077	135	125	5,6	1000	4,500	8	8	30.57 €
PB40000220079	135	125	5,6	2000	8,500	8	8	55.28 €
PB40000220081	135	125	5,6	3000	11,750	8	1	76.20 €
PB40000220095	160	150	5,6	500	2,759	4	4	22.65 €
PB40000220097	160	150	5,6	1000	5,250	8	8	38.52 €
PB40000220099	160	150	5,6	2000	5,000	8	8	69.12 €
PB40000220101	160	150	5,6	3000	14,500	8	1	102.78 €

HTB curva 15°

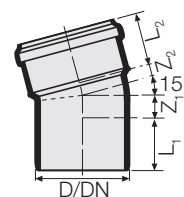

COD.	D	DN	Z ₁	L ₁	Z ₂	L ₂	kg		QMM	€/un
PB40000221001	58	50	4	70	8	55	0,185	4	4	8.21 €
PB40000221011	78	70	6	60	10	60	0,261	4	4	8.21 €
PB40000221021	90	90	8	60	8	60	0,305	4	4	10.92 €
PB40000221031	110	100	27	61	15	65	0,521	4	4	11.71 €
PB40000221041	135	125	29	64	10	70	0,720	4	4	18.29 €
PB40000221051	160	150	13	66	19	70	0,914	4	4	25.34 €

HTB curva 30°

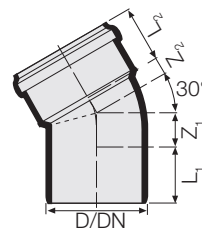

COD.	D	DN	Z ₁	L ₁	Z ₂	L ₂	kg		QMM	€/un
PB40000221003	58	50	8	70	16	55	0,190	4	4	8.33 €
PB40000221013	78	70	11	60	30	60	0,276	4	4	8.33 €
PB40000221023	90	90	14	60	14	60	0,330	4	4	11.51 €
PB40000221033	110	100	37	61	19	65	0,568	4	4	12.07 €
PB40000221043	135	125	38	64	45	70	0,797	4	4	18.65 €
PB40000221053	160	150	24	66	30	70	1,031	4	4	25.34 €

HTB curva 45°

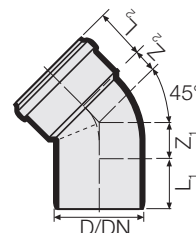

COD.	D	DN	Z ₁	L ₁	Z ₂	L ₂	kg		QMM	€/un
PB40000221005	58	50	28	70	17	55	0,196	4	1	8.73 €
PB40000221015	78	70	37	60	21	60	0,302	4	1	9.13 €
PB40000221025	90	90	22	60	20	60	0,343	4	1	11.64 €
PB40000221035	110	100	44	61	28	65	0,611	4	1	12.63 €
PB40000221045	135	125	50	64	34	70	0,875	4	1	18.81 €
PB40000221055	160	150	30	66	42	70	1,148	4	1	25.22 €

HTB curva 87°30'

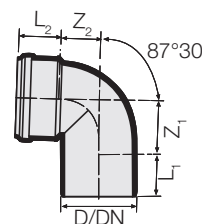

COD.	D	DN	Z ₁	L ₁	Z ₂	L ₂	kg		QMM	€/un
PB40000221009	58	50	47	70	32	55	0,229	4	1	9.36 €
PB40000221019	78	70	62	60	42	60	0,359	4	1	9.36 €
PB40000221029	90	80	49	60	42	60	0,427	4	1	12.40 €
PB40000221039	110	100	78	61	58	65	0,743	4	1	13.27 €
PB40000221049	135	125	96	64	102	70	1,096	4	1	21.40 €
PB40000221059	160	150	83	66	89	70	1,496	4	1	30.17 €

GAMA SILERE

HTEA forquilha 45°

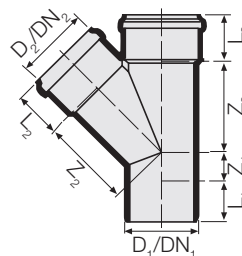

COD.	D ₁ /D ₂	DN ₁ /DN ₂	Z ₁	L ₁	Z ₂	L ₂	Z ₃	L ₃	kg		QMM	€/un
PB40000222005	58/58	50/50	12	70	75	55	75	55	0,375	4	1	15.74 €
PB40000222007	78/58	70/50	2	60	99	60	100	55	0,528	4	1	15.74 €
PB40000222009	78/78	70/70	16	60	99	60	99	60	0,610	4	1	17.01 €
PB40000222011	90/58	80/50	19	60	113	60	113	55	0,614	4	1	20.04 €
PB40000222013	90/90	90/90	19	60	116	60	113	60	0,736	4	1	16.85 €
PB40000222015	110/58	100/50	1	61	110	65	97	55	0,789	4	1	19.57 €
PB40000222017	110/78	100/70	21	61	122	65	115	60	0,905	4	1	21.32 €
PB40000222018	110/90	100/90	44	61	168	60	136	70	1,347	4	1	24.47 €
PB40000222019	110/110	100/100	44	61	136	70	136	70	1,282	4	1	23.28 €
PB40000222021	135/110	125/100	49	64	169	70	169	65	1,699	2	1	35.42 €
PB40000222023	135/135	125/125	49	64	169	70	169	70	1,888	2	1	44.07 €
PB40000222025	160/110	150/100	36	95	180	70	200	70	1,831	2	1	47.70 €
PB40000222027	160/160	150/150	36	95	200	70	200	70	2,493	2	1	61.91 €

HTEA Forquilha
87°30'

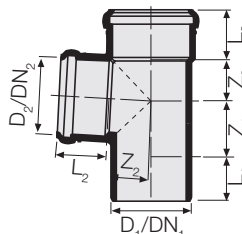

COD.	D ₁ /D ₂	DN ₁ /DN ₂	Z ₁	L ₁	Z ₂	L ₂	Z ₃	L ₃	kg		QMM	€/un
PB40000224005	58/58	50/50	28	70	32	55	32	55	0,310	4	1	16.57 €
PB40000224007	78/58	70/50	27	60	43	60	43	55	0,419	4	1	15.74 €
PB40000224009	78/78	70/70	37	60	43	60	43	60	0,474	4	1	17.01 €
PB40000224015	110/58	100/50	47	61	61	65	27	55	0,680	4	1	19.61 €
PB40000224017	110/78	100/70	60	61	61	65	43	55	0,774	4	1	21.32 €
PB40000224018	110/90	100/90	78	91	91	60	58	70	1,110	4	1	24.47 €
PB40000224019	110/110	100/100	78	61	58	70	58	70	0,988	4	1	23.28 €
PB40000224021	135/110	125/100	90	64	72	70	72	65	1,402	2	1	35.42 €
PB40000224023	135/135	125/125	90	64	72	70	72	70	1,431	2	1	44.46 €

Forquilha curva 87°30'

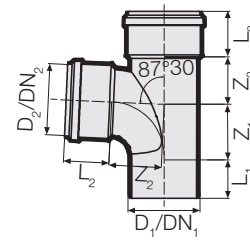

COD.	D ₁ /D ₂	DN ₁ /DN ₂	Z ₁	L ₁	Z ₂	L ₂	Z ₃	L ₃	kg		QMM	€/un
PB40000238011	110/110	100/100	78	65	80	70	72	70	1,098	4	1	32.51 €

HTDA forquilha dupla 87°30'

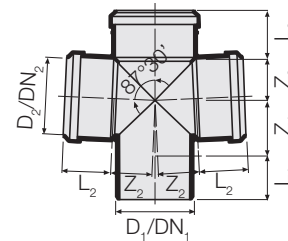

COD.	D ₁ /D ₂	DN ₁ /DN ₂	Z ₁	L ₁	Z ₂	L ₂	Z ₃	L ₃	kg		QMM	€/un
PB40000225011	110/110	100/100	78	61	58	70	58	70	1,168	2	2	59.76 €
PB40000225013	135/110	125/100	80	84	74	71	72	70	1,510	2	2	82.34 €

Peça soldada.

HTED forquilha de ângulo 87°30'

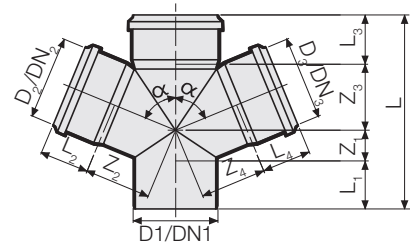
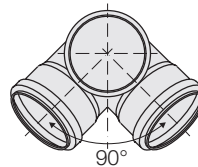

COD.	D _{1/2/3}	DN _{1/2/3}	α	Z ₁	Z _{2/4}	Z ₃	L	L ₁	L _{2/4}	L ₃	kg				QMM	€/un
PB40000225014	110/110/110	100/100/100	87°30'	54	72	65	242	63	58	61	0,840	5	20	60	5	53.43 €

Forquilha paralela

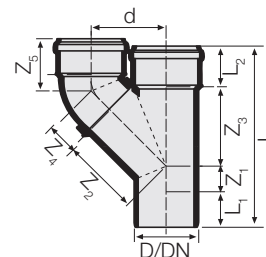

COD.	D	DN	Z ₁	Z ₂	Z ₃	Z ₄	Z ₅	d	L ₁	L	kg		QMM	€/un
PB40000233011	110	100	44	136	136	56	89	134	61	310	1,548	2	2	85.30 €

Peça soldada.

GAMA SILERE

VBF
Forquilha
misturadora

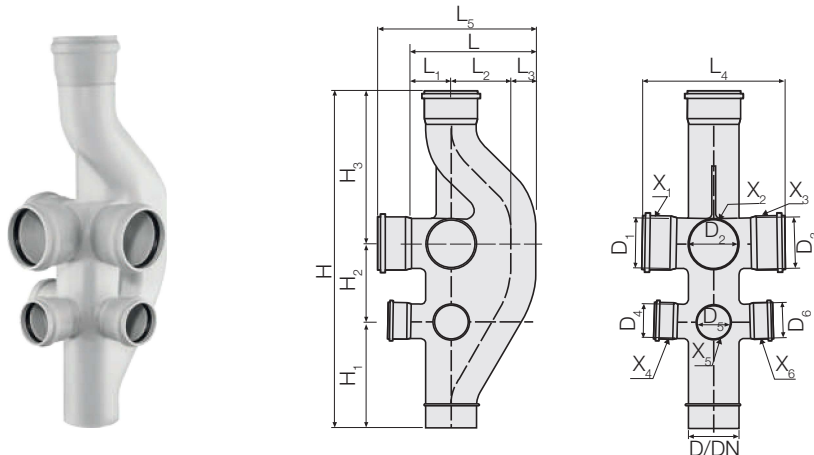

COD.	D	DN	D _{1/2/3}	D _{4/5/6}	L	L ₁	L ₂	L ₃	L ₄	L ₅	H	H ₁	H ₂	H ₃	€/un
PB40000273X ₁ X ₂ X ₃ X ₄ X ₅ X ₆ *	110	100	110	78	265	85	130	50	300	345	780	245	170	365	**

* O "X" assume o valor de 0 a entrada não for necessária, caso contrário assume o valor de 1 e é soldado um encaixe. Está previsto um lote mínimo por encomenda.

** Sob encomenda.

**HTRE forquilha de
inspeção com tampa
roscada**

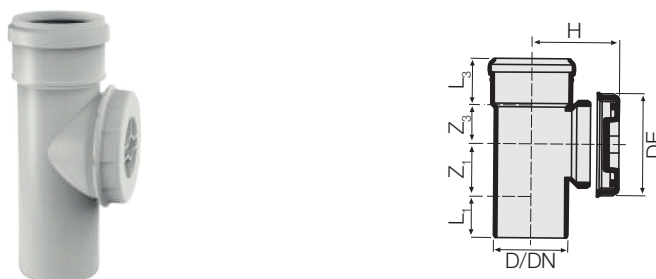

COD.	D	DN	Z ₁	L ₁	Z ₃	L ₃	H	DE	kg		QMM	€/un
PB40000227005	58	50	28	70	32	55	72	90	0,405	4	1	19.92 €
PB40000227007	78	70	37	60	43	60	82	120	0,619	4	1	21.76 €
PB40000227011	110	100	78	61	58	70	110	150	1,087	4	1	30.68 €
PB40000227013	135	125	90	64	72	65	115	150	1,455	4	1	63.70 €
PB40000227015	160	150	80	95	80	70	120	150	1,768	2	1	80.68 €

**HTR redução
excêntrica**

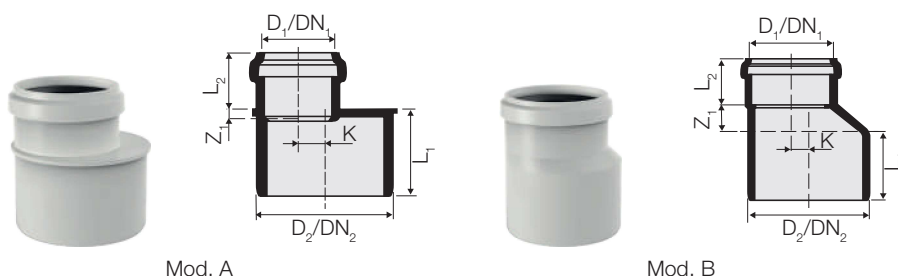

COD.	D ₁ /D ₂	DN ₁ /DN ₂	Mod.	K	Z ₁	L ₁	L ₂	kg		QMM	€/un
PB40000226005	58/78	50/70	A	5	10	60	55	0,190	4	1	6.26 €
PB40000226007	58/90	50/90	A	11	10	67	55	0,227	4	1	8.85 €

COD.	D ₁ /D ₂	DN ₁ /DN ₂	Mod.	K	Z ₁	L ₁	L ₂	kg		QMM	€/un
PB40000226009	78/90	70/90	A	0	15	67	60	0,239	4	1	9.25 €
PB40000226011	58/110	50/100	A	22	10	70	55	0,313	4	1	8.09 €
PB40000226013	78/110	70/100	A	11	10	70	60	0,349	4	1	8.21 €
PB40000226015	90/110	90/100	A	5	10	70	60	0,343	4	1	10.64 €
PB40000226017	110/135	100/125	B	7	15	85	65	0,565	4	1	13.51 €
PB40000226019	110/160	100/150	B	23	35	90	65	0,769	4	1	17.89 €
PB40000226021	135/160	125/150	B	10	32	90	70	0,817	4	1	20.04 €

Tampão

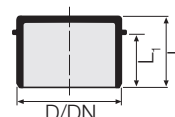

COD.	D	DN	L ₁	L	kg		QMM	€/un
PB40000230005	58	50	50	65	0,177	4	1	4.43 €
PB40000230007	78	70	51	66	0,147	4	1	6.38 €
PB40000230009	90	90	51	66	0,162	4	1	7.93 €
PB40000230011	110	100	56	72	0,287	4	1	9.49 €
PB40000230013	135	125	60	77	0,406	4	1	13.86 €
PB40000230015	160	150	45	63,5	0,449	4	1	17.89 €

Abraçadeira tampão

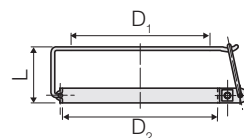

COD.	D	D ₁	D ₂	L	kg		QMM	€/un
PB40000250005	58/50	59	69	41	0,075	10	10	31.72 €
PB40000250007	78/70	79	99	41	0,087	10	10	40.04 €
PB40000250009	90/90	91	102	41	0,094	10	10	40.99 €
PB40000250011	110/100	111	123	46	0,115	10	10	41.44 €
PB40000250013	135/125	136	146	47	0,132	10	10	43.99 €
PB40000250015	160/150	161	181	47	0,142	10	10	49.40 €

HTU união deslizante

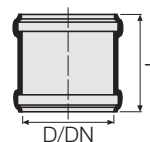

COD.	D	DN	L	kg		QMM	€/un
PB40000228005	58	50	105	0,165	4	1	5.58 €
PB40000228007	78	70	107	0,233	4	1	5.58 €
PB40000228011	110	100	117	0,393	4	1	5.78 €
PB40000228013	135	125	126	0,535	4	1	7.69 €
PB40000228015	160	150	147	0,742	4	1	12.63 €
						1	15.38 €

GAMA SILERE

União dupla

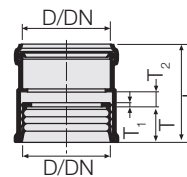

COD.	D	DN	T	T ₁	T ₂	L	kg		QMM	€/un
PB40000229005	58	50	48	5	15	119	0,228	4	1	5.04 €
PB40000229007	78	70	48	6	16	119	0,303	4	1	5.61 €
PB40000229009	90	90	47	6	16	124	0,360	4	1	6.01 €
PB40000229011	110	100	48	6	16	124	0,484	4	1	6.42 €
PB40000229013	135	125	65	6	16	145	0,726	4	1	10.96 €
PB40000229015	160	150	65	6	16	147	0,858	4	1	12.92 €

Ligação
PP/HDPE - SILERE

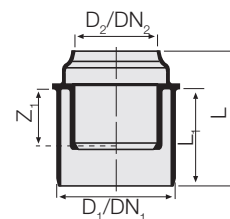

COD.	D ₁ /D ₂	DN ₁ /DN ₂	Z ₁	L	L ₁	kg		QMM	€/un
PB40000231001	58/40	50/40	30	67	50	0,035	4	1	4.95 €
PB40000231003	58/50	50/50	25	86	60	0,043	4	1	5.23 €
PB40000231005 *	78/50	70/50	37	75	60	0,052	4	1	5.30 €
PB40000231007	78/75	70/70	0	112	60	0,060	4	1	5.30 €
PB40000231013	135/125	125/125	0	138	70	0,205	2	1	7.90 €

* Excêntrico

Ligação
SILERE - PP/HDPE

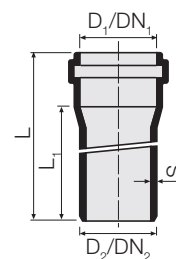

COD.	D ₁ /D ₂	DN ₁ /DN ₂	L	L ₁	s ₁	kg		QMM	€/un
PB40000237003	58/50	50/50	145	60	2,5	0,134	4	4	13.31 €
PB40000237007	78/75	70/70	150	70	3,5	0,203	4	4	13.55 €
PB40000237013	135/125	125/125	190	75	3,5	0,610	2	2	39.21 €

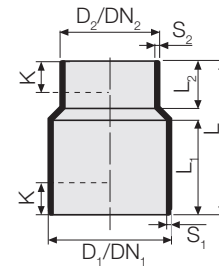
**Ligação
HDPE - SILERE**

COD.	D ₁ /D ₂	DN ₁ /DN ₂	S ₁ /S ₂	L	L ₁	L ₂	K	kg				QMM	€/un
PB40000336061	58/56	50/50	3	95	60	30	15	0,047	20	160	1600	20	5.34 €
PB40000336063	78/63	70/60	3	100	60	30	15	0,064	20	160	960	20	6.14 €

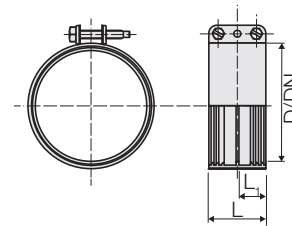
**Abraçadeira de
compressão**

COD.	D	DN	L ₁	L	kg				QMM	€/un
PB40000271005	58	50	20,5	44	0,136	20	320	1600	20	9.88 €
PB40000271007	78	70	22,5	48	0,155	20	160	800	20	8.68 €
PB40000271011	110	100	25,5	55	0,216	20	160	640	20	8.68 €
PB40000271013	135	125	28	60	0,272	10	80	400	10	15.28 €
PB40000271015	160	150	30	65	0,359	10	80	400	10	20.91 €

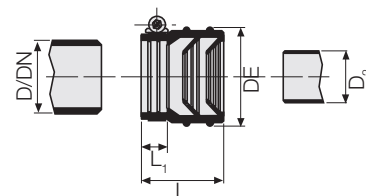
**União de ligação
tubo de ferro**

COD.	D	DN	D ₂	DE	L ₁	L	kg		QMM	€/un
PB40000272005	58	50	40/56	77	20	63	0,142	20	20	6.66 €
PB40000272007	78	70	56/75	97	20	77	0,213	20	20	8.57 €
PB40000272011	110	100	104/110	133	20	95	0,305	20	20	13.86 €